



STRUCTURAL DESIGN OF STEEL CONNECTIONS AND JOINTS

IDEA StatiCa®

Calculate yesterday's estimates

WHY WE DEVELOP IDEA STATICA

IDEA StatiCa is an engineering software dedicated to structural design and code-check of joints, cross sections, beams and other details in structures. We develop it for structural engineers, fabricators, detailers and all others who perform or use structural analysis. Our development team researches, tests and applies new methods of analyzing behavior of structures. IDEA StatiCa enables engineers to work faster, evaluate requirements of the national code thoroughly and use optimal amount of material. For us, creating software is a way to contribute to making every new construction around the world safer and cheaper.



Creating software for structural engineering is a complex process. The final user (engineer) sees the GUI and the report. But the story of every IDEA StatiCa application starts years before any GUI is available – with research and development which combines physics, mechanics and deep understanding of codes of practice. And IDEA StatiCa cannot do this alone so we cooperate with technical universities, especially with engineering faculties at ETH Zurich, CVUT Prague and VUT Brno.



OUR TEAM





Steel connection design - reinvented

IDEA StatiCa introduces a novel way to design and check all steel connections and joints. With it, engineers can break the limits of standard connection design tools to save time and optimize the material usage. Clear pass/fail checks according to the EC/AISC/CISC code are available in minutes, as well as complete output reports.



IDEA StatiCa Connection

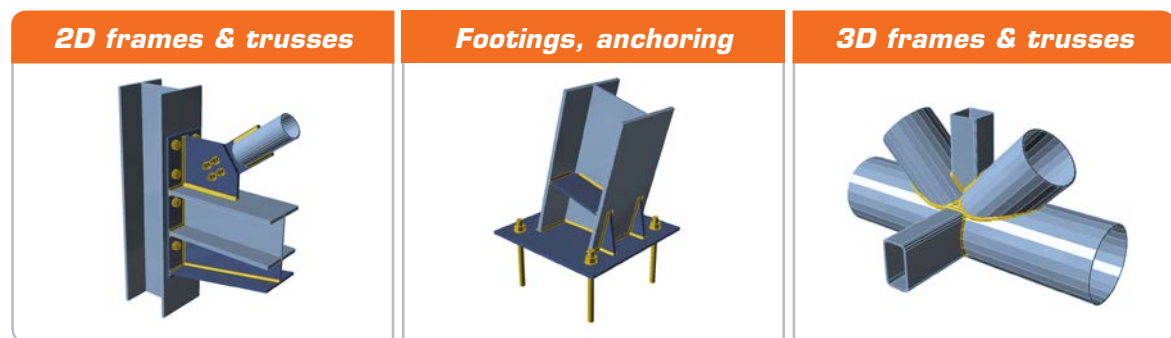

IDEA StatiCa Connection can design all types of welded or bolted connections, base plates, footing and anchoring. It provides precise checks, results of strength, stiffness and buckling analysis of a steel joint. Bolts, welds and concrete blocks are checked according to the EC/AISC/CISC code. Templates for most-used connections are available as well as wide range of predefined hot rolled and sheet welded members.

ANY TOPOLOGY

No limits in how many connections there are in the joint, what is their type and how they are put together. Shape is defined by project requirements, not by software capabilities.

ANY LOADING

All forces are analyzed. The overall check of the joint takes into account interactions between all the beams and connections. Engineers stays on the safe side all the time.

IN MINUTES

The whole design and check process is kept short enough to be a part of everyday work of structural engineers and fabricators all around the world.



Work with data from other programs

IDEA StatiCa Connection

FEA software

Design your joint from scratch or build on geometry and loading imported from SCIA Engineer, AxisVM, RFEM, Robot, Revit, SAP2000, ConSteel, ETABS, Advance Design, STAAD.Pro

CAD software

Take advantage of integration with Tekla Structures and Advance Steel to provide workshop drawings and support manufacturing process

Changing the way how we calculate connections and joints in steel structures

Engineers typically design steel connections that follow prescribed building code requirements based on laboratory testing, computational model verification and engineering judgment. However, many projects have situations where the connection design must be validated by a more comprehensive connection analysis. This can be very time-consuming and requires advanced software equipment, impacting profitability. A project-specific way of studying connection behavior is needed to ensure safety of the design while increasing productivity of the whole engineering process.

IDEA StatiCa Connection provides

Overall check

According to various national design codes

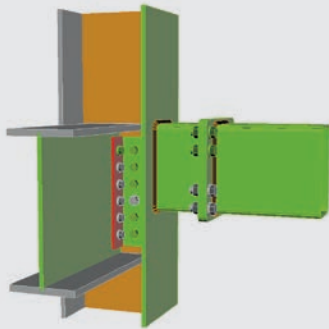

Stress/strain analysis

FE model of steel joint is composed automatically

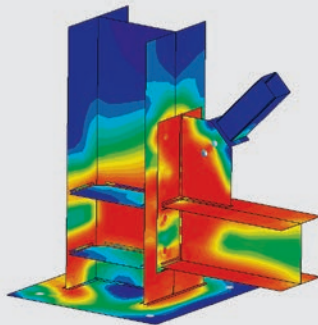

Stiffness analysis

Rotational or transversal stiffness of any connection

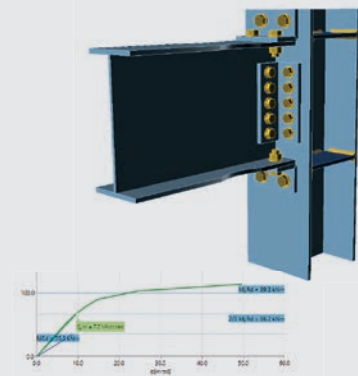

Member capacity design

Seismic check of non-dissipative connections

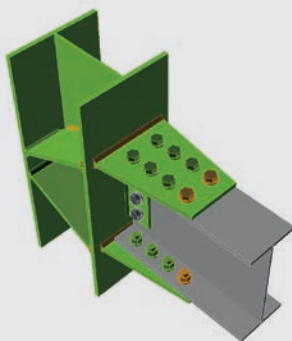

Buckling analysis

Local buckling effects and critical load factors

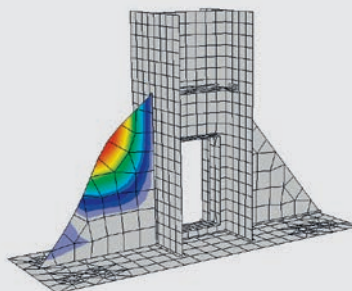

Design joint resistance

Maximal possible loads, reserve in joint capacity

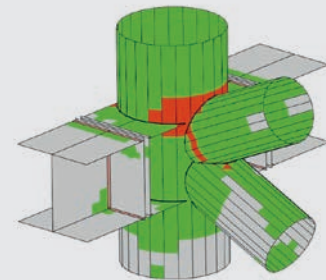

Output report

IDEA StatiCa provides a fully customizable report in Adobe PDF and Microsoft DOC. All checks with related formulas according to the selected code are displayed. We can also generate drawings and bill of material.

Project: Tutorial
Project no: 2a
Author: IDEA StatiCa Team

Project data

Project name: Tutorial
Project number: 2a
Author: IDEA StatiCa Team
Description: Connection design and check tutorial
Date: 3/19/2018
Design code: EN

Steel connection design – reinforced

A novel way to design and check all steel connections according to the code, in minutes.

IDEA StatiCa Connection can design all types of welded or bolted connections, base plates, footing and anchoring. It provides precise checks, results of strength, stiffness and buckling analysis of a steel joint. Bolts, welds and concrete blocks are checked according to EC3-1-2. Templates for reinforced connections are available as well as wide range of predefined hot rolled and steel welded members.

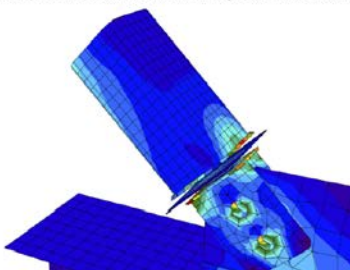

New CBFEM method inside changes the game of structural joint design

Together with top technical universities, we created a new method for analysis and check of steel joints of general shapes and loading. It is called Component-Based Finite element model (CBFEM). After 5 years of primary research and theoretical preparations, the 1st version of the application was tested in 24 months and released in May 2014.

Project: Tutorial
Project no: 2a
Author: IDEA StatiCa Team

Detailed result for B2

$F_{t,Rd} = \frac{A_s f_{t,Rk}}{\gamma_{M2}} = 81.0 \text{ kN}$
 $F_{t,Rd} = \frac{A_s f_{t,Rk}}{\gamma_{M2}} = 81.0 \text{ kN}$
 $F_{t,Rd} = \frac{A_s f_{t,Rk}}{\gamma_{M2}} = 10.2 \text{ kN}$
 $F_{t,Rd} = \frac{A_s f_{t,Rk}}{\gamma_{M2}} = 80.4 \text{ kN}$

where:
 $\gamma_{M2} = 0.90$ – Factor
 $f_{t,Rk} = 800 \text{ MPa}$ – Ultimate tensile strength of the bolt
 $A_s = 107 \text{ mm}^2$ – Tensile stress area of the bolt
 $\gamma_{M2} = 1.25$ – Safety factor

$F_{t,Rd} = \frac{A_s f_{t,Rk}}{\gamma_{M2}} = 104.7 \text{ kN}$

where:
 $\gamma_{M2} = 0.90$ – Factor
 $f_{t,Rk} = 800 \text{ MPa}$ – Ultimate tensile strength of the bolt
 $A_s = 107 \text{ mm}^2$ – Tensile stress area of the bolt
 $\gamma_{M2} = 1.25$ – Safety factor

$F_{t,Rd} = \frac{A_s f_{t,Rk}}{\gamma_{M2}} = 62.3 \text{ kN}$

where:
 $\gamma_{M2} = 1.00$ – Reducing factor
 $f_{t,Rk} = 800 \text{ MPa}$ – Ultimate tensile strength of the bolt
 $A_s = 107 \text{ mm}^2$ – Tensile stress area of the bolt
 $\gamma_{M2} = 1.25$ – Safety factor

$F_{t,Rd} = \frac{A_s f_{t,Rk}}{\gamma_{M2}} = 106.0 \text{ kN}$

where:
 $\gamma_{M2} = 2.00$ – Factor for edge distance and bolt spacing perpendicular to the direction of load transfer – EN 1090-1-8 – Table 3.4
 $\gamma_{M2} = 0.90$ – Factor
 $f_{t,Rk} = 800 \text{ MPa}$ – Ultimate strength
 $d = 18 \text{ mm}$ – Nominal diameter of the fastener
 $t = 12 \text{ mm}$ – Thickness
 $\gamma_{M2} = 1.25$ – Safety factor

Project: Tutorial
Project no: 2a
Author: IDEA StatiCa Team

Bolts

Name	Grip length [mm]	Count
M10 8.8	20	8

Drawing

EP1

P10 8x45-110 (S 355)

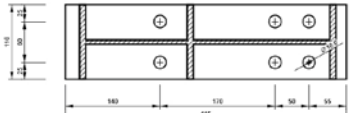

WD1 - 1

P5 3x330-100 (S 355)

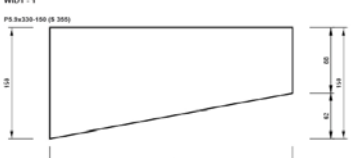

Validation and verification of results

Together with technical universities, we tested and verified results of IDEA StatiCa Connection. The first level of testing was to design and calculate typical joints described in design guides and compare the results with IDEA StatiCa Connection.

The second level of testing was dedicated to non-standard connections and joints. We laboriously created advanced FEA models and compare results with IDEA StatiCa Connection. The third level was live testing in university laboratories. For example, gradual loading of a footing until it was ripped from a concrete block.

This thorough examination confirmed accuracy and reliability of IDEA StatiCa Connection. All verification and validation studies are published and available to the engineering public. Our new approach to steel connection design has already been presented on tens of international conferences and meetings of regulatory bodies all around the world. We are happy to see its wide acceptance amongst academics, structural engineers, fabricators, code-checkers and other industry professionals.



Four steps to create your connection in seconds

1. Select Class
In plane or spatial node? Anchoring?

2. Select Topology
How your node looks like?

3. Select Design
Find appropriate design.

4. Select Parameters

Name:	T joint
Description:	Template
Steel grade:	S 355
Bolt assembly:	M16 8.8
Concrete grade:	C25/30

Design code:

Create project

Class of the joint

Topology of the joint

Design of the joint

Final setup

Hundreds of predefined connection templates

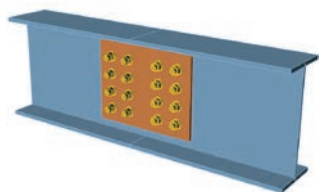

Web splice

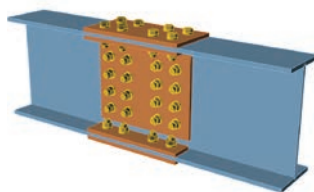

Web and flanges splices,
backplates

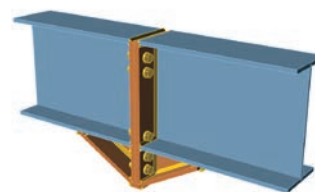

Plate to plate, haunches

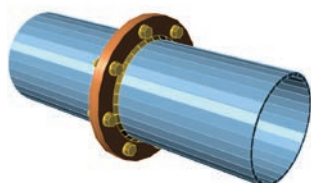
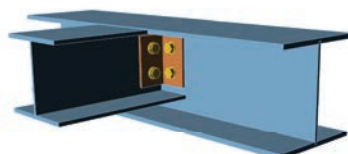
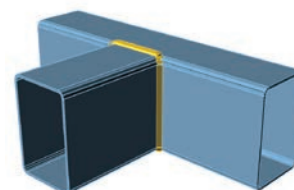

Plate to plate, circular
cross-section



Welded, notched top flange



Welded, rectangular cross-section

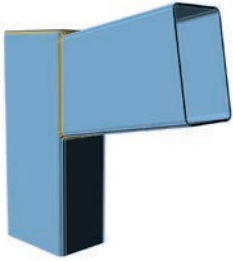
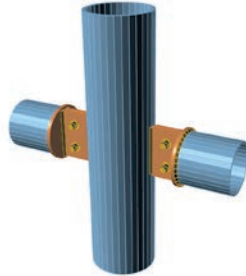
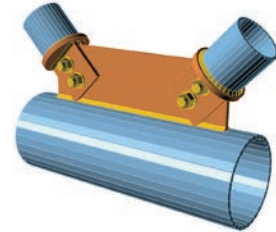

Plate to plate corner connection



Hinge connecting plate, circular cross-section



Hinge gusset plate, circular cross-section

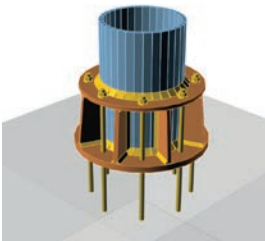

Heavy anchoring

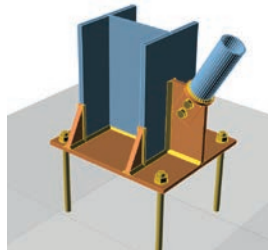

Column anchoring, wideners

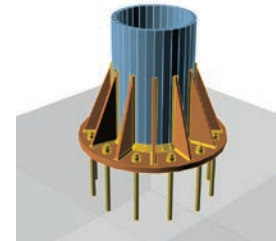

Column anchoring, ribs

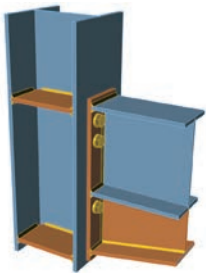

End plate, stiffeners, long haunch

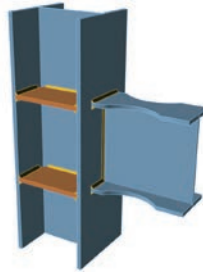

Stiffeners, dog bone

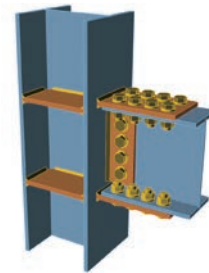

Fin plates, stiffeners

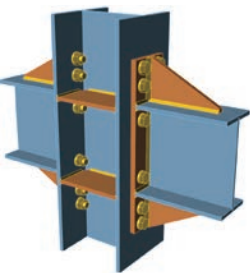

End plates, haunches

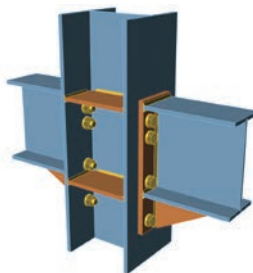

End plates, bottom haunches

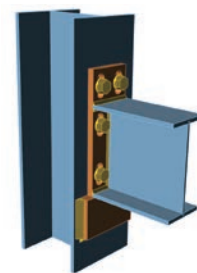

Slotted holes, shear tab

Plates

Model is composed of steel plates – both parts of steel members and connecting plates are simulated by shell elements. Real shape of plates is kept. Each plate is meshed independently. Equivalent stress and plastic strain are checked.

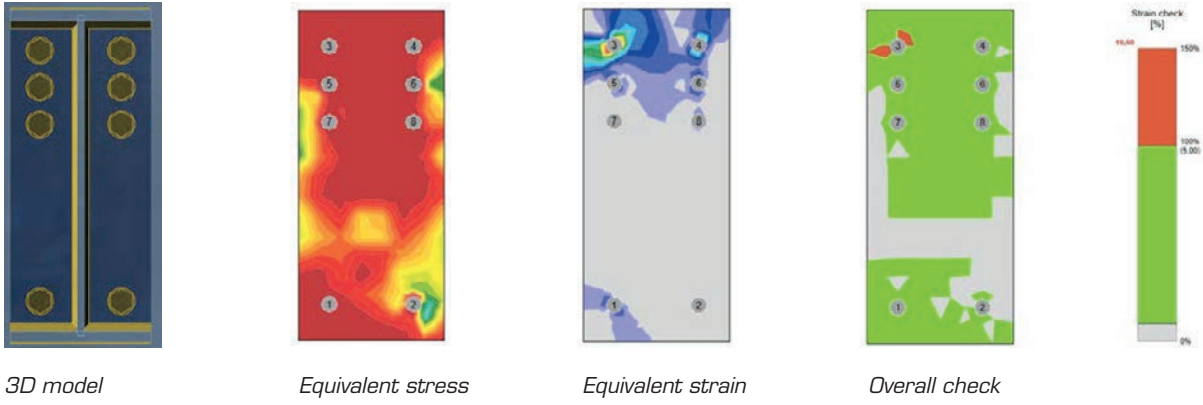

Welds

Welds are modelled as solid elements which are connected with the plates with interpolation links. The plastic redistribution of stress is used to correctly determine the resistance of weld component by redistributing stress peaks into further weld elements. Forces in each weld element are evaluated. Stress in weld is checked according to EN/AISC/CISC.

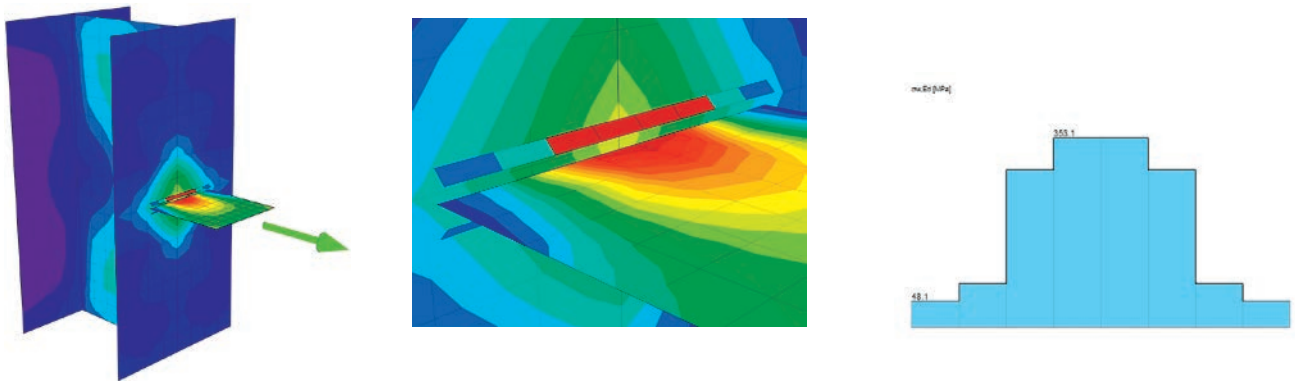

3D visualisation of Equivalent stress. Output table with results. Equivalent stress in weld.

Status	Item	Edge	Th [mm]	L [mm]	Loads	$\sigma_{w,Ed}$ [MPa]	s,PI [%]	$\sigma_{\perp,L}$ [MPa]	$\tau_{ }$ [MPa]	$\tau_{\perp,L}$ [MPa]	Ut [%]	Utc [%]
✓	C-bfl 1	B-bfl 1	44.0	100	LE1	353.1	0.2	160.9	-84.0	160.9	98.1	53.8

Result tables for the weld

$$UT = \max\left(\frac{\sigma_{w,Ed}}{\sigma_{w,Rd}}; \frac{|\sigma_{\perp,L}|}{\sigma_{\perp,Rd}}\right) = 98.1 \%$$

$$\sigma_{w,Ed} = [\sigma_{\perp}^2 + 3(\tau_{\perp}^2 + \tau_{||}^2)]^{0.5} = 353.1 \text{ MPa}$$

$$\sigma_{w,Rd} = f_u / (\beta_w \gamma_{M2}) = 360.0 \text{ MPa}$$

$$\sigma_{\perp,Rd} = 0.9 f_u / \gamma_{M2} = 259.2 \text{ MPa}$$

where:
 $f_u = 360.0 \text{ MPa}$ – Ultimate strength
 $\gamma_{M2} = 1.25$ – Safety factor

Formulas and values for the weld

Bolts

Standard or preloaded bolts are nonlinear springs taking tension and shear.

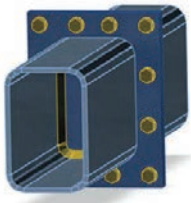

3D model

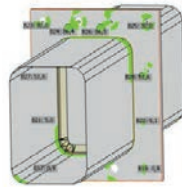

Tension forces

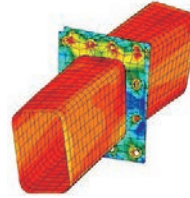

Deformed shape

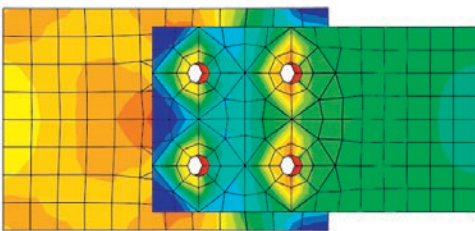

Standard bolts – Force transfer by bearing

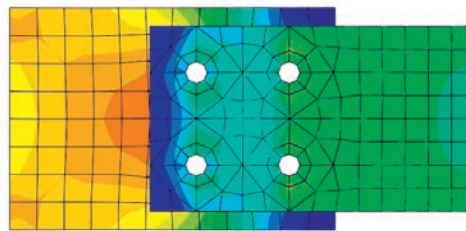

Preloaded bolts – Force transfer by friction between members



Slotted holes – release of the stress in the defined direction

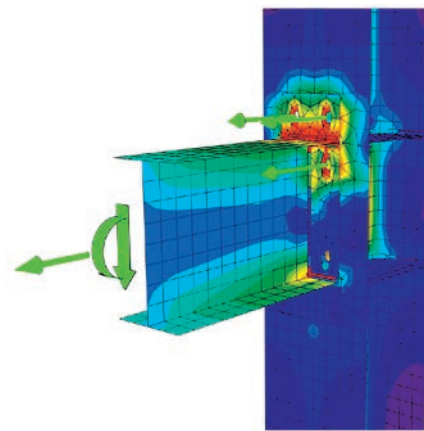

Transfer of the shear force to another component

Status	Item	Loads	Ft [kN]	V [kN]	Fb,Rd [kN]	Utt [%]	Uts [%]	Utts [%]
✓	B1	LE1	182.5	3.5	156.8	89.8	2.6	66.7

Result tables for the bolt

$$F_{b,Rd} = \frac{k_1 a_b f_u d t}{\gamma_{M2}} = 156.8 \text{ kN}$$

where:

- $k_1 = 2.50$ – Factor for edge distance and bolt spacing perpendicular to the direction of load transfer - EN 1993-1-8 - Table 3.4
- $a_b = 0.67$ – Factor
- $f_u = 490.0 \text{ MPa}$ – Ultimate strength
- $d = 24 \text{ mm}$ – Nominal diameter of the fastener
- $t = 10 \text{ mm}$ – Thickness
- $\gamma_{M2} = 1.25$ – Safety factor

Formulas and values for the bolt

Concrete block

Steel structure can be anchored into concrete block. Base plate is in contact with concrete. Tension is taken by anchors, shear by anchors, friction or shear iron.

Anchorage can be defined to as a direct, mortar joint or with gap between foundation block and plate.

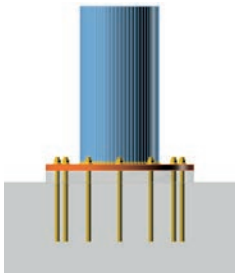

Mortar joint



Contact stress area

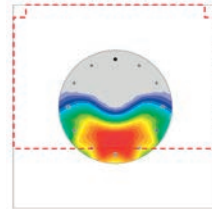

Break out cones

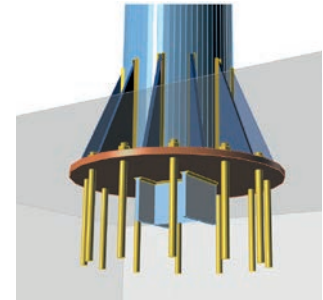

Shear iron

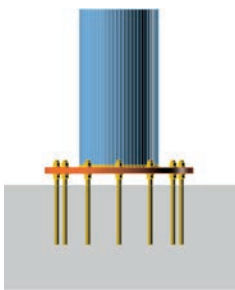

Gap

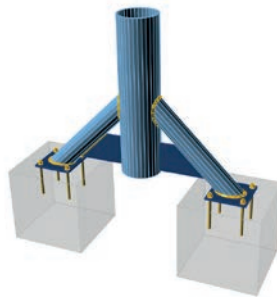

Multiple anchoring

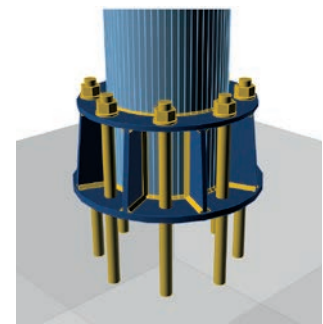

Heavy anchoring

Status	Item	Grade	Loads	Ft [kN]	V [kN]	Nrdc [kN]	Vrds [kN]	Utt [%]	Uts [%]	Utts [%]	Vrd,cp [kN]	Vrd,c [kN]	Vrd,cp,s	Vrd,cs
✓	A1	M16 8.8 - 1	LE1	35.0	4.2	58.3	50.2	60.1	8.3	49.7	109.0	42.8	✓	✓

Result tables for the anchor

$$N_{Rk,c} = N_{Rk,c}^0 \cdot \frac{A_{c,N}}{A_{c,N}^0} \cdot \psi_{s,N} \cdot \psi_{re,N} \cdot \psi_{ec,N} = 104.9 \text{ kN}$$

where:

- $A_{c,N} = 360400 \text{ mm}^2$ – Actual area of concrete cone
- $A_{c,N}^0 = 462400 \text{ mm}^2$ – Area of concrete of an individual anchor with large spacing
- $N_{Rk,c}^0 = 134.6 \text{ kN}$ – Characteristic resistance of an anchor placed in cracked concrete
- $\psi_{s,N} = 1.00$ – Factor of distribution of stresses in the concrete
- $\psi_{re,N} = 1.00$ – Shell spalling factor
- $\psi_{ec,N} = 1.00$ – Group effect factor

Formulas and values for the anchor

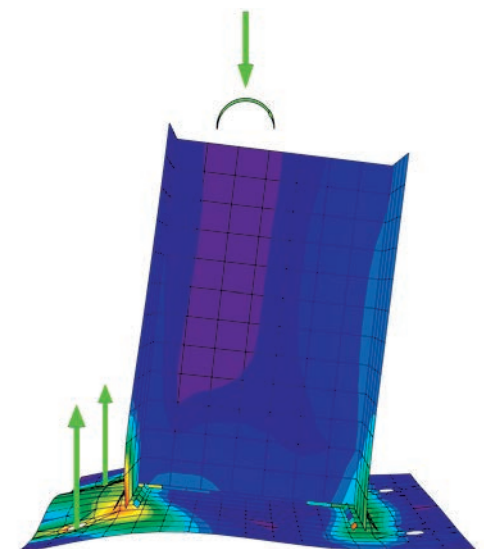

Anchoring deformed shape, prying creates increment to the tension force

Working in the BIM

IDEA StatiCa Connection is not just a standalone application where we define geometry, loads and other inputs from scratch. It has BIM interface that allows us to build on models created in other engineering applications to save time and avoid errors.

Workflow with FEA programs

Let's say we have a steel structure created in SAP 2000, Robot Structural Analysis, STAAD.Pro, ETABS, SCIA Engineer, RFEM, AxisVM, Revit, Advance Design, ConSteel or other finite-element analysis software integrated with IDEA StatiCa. And we want to code-check a connection. We easily export the node (geometry, cross-sections, load effects), design the connection in IDEA StatiCa and perform the code-check.

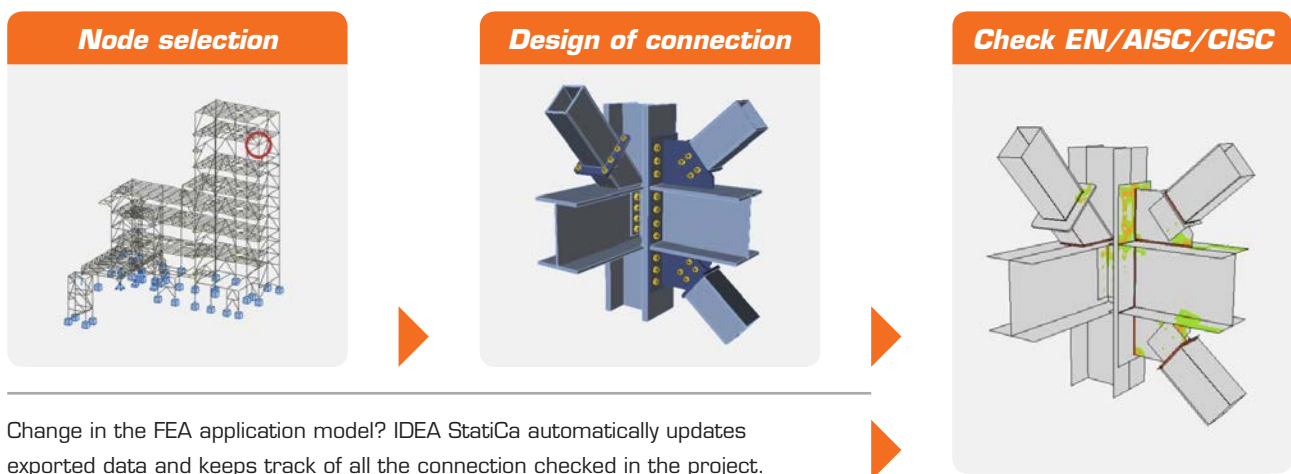

Change in the FEA application model? IDEA StatiCa automatically updates exported data and keeps track of all the connection checked in the project.

Workflow with CAD/BIM programs

IDEA StatiCa is also integrated into Tekla Structures and Advance Steel. Fully detailed connection created in these CAD/BIM programs can be easily exported to IDEA StatiCa. Then we load it and perform the code-check in IDEA StatiCa.

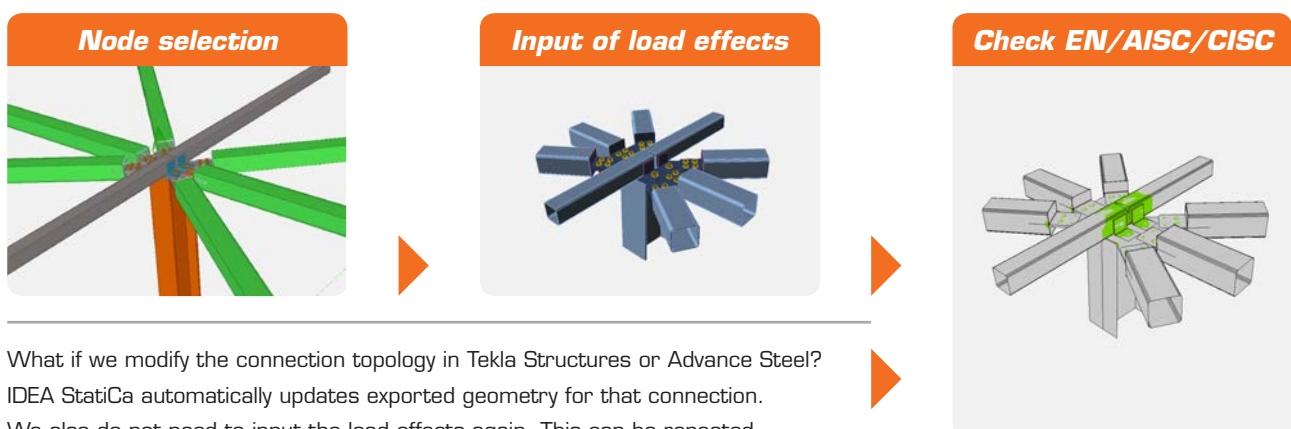

What if we modify the connection topology in Tekla Structures or Advance Steel? IDEA StatiCa automatically updates exported geometry for that connection. We also do not need to input the load effects again. This can be repeated several times to optimize the design.

Designed by IDEA StatiCa Connection

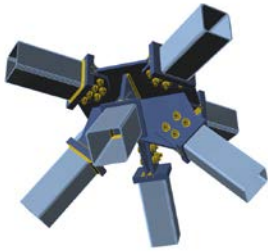

Stadium roof

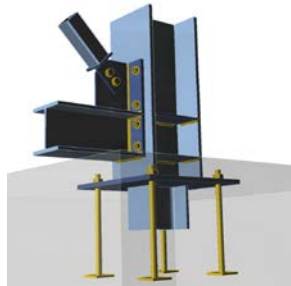

Warehouse

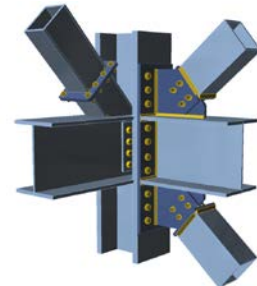

Industry hall

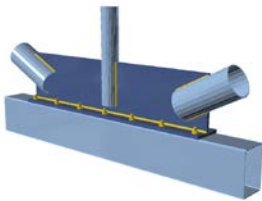

Pedestrian Bridge

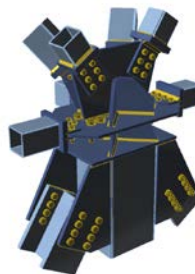

Power plant

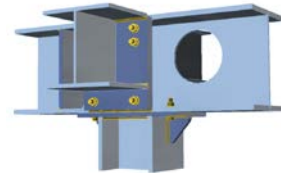

Stadium roof

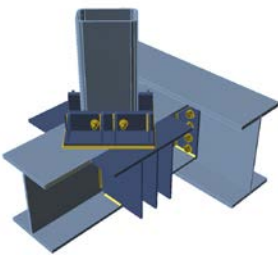

Crane support structure

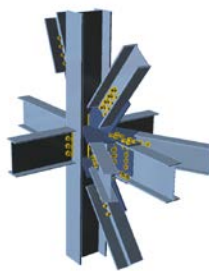

Congress centre

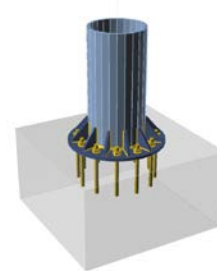

Lightning column

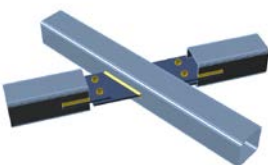

Facade secondary structure

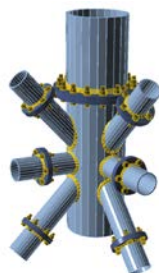

Broadcast tower

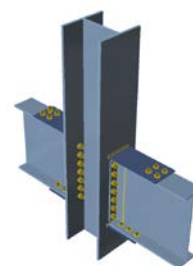

Congress centre

Designed by IDEA StatiCa Connection



Shopping mall

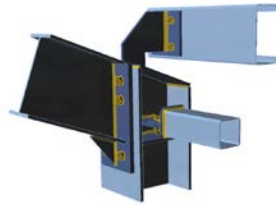

Warehouse



Shopping mall

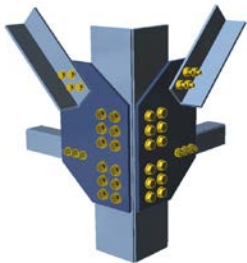

Tower mast

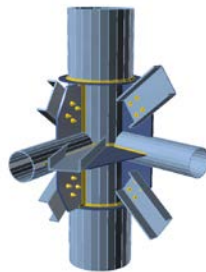

Off-shore structure

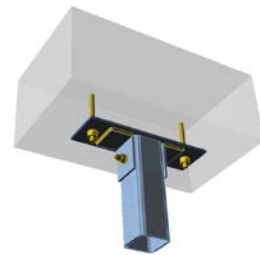

Canopy



Facade secondary structure

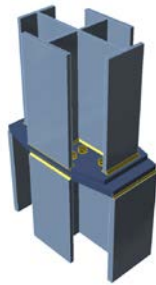

Shopping mall

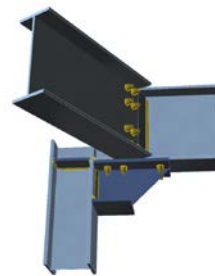

Industry hall

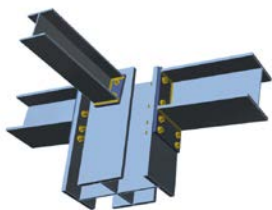

Theatre roof

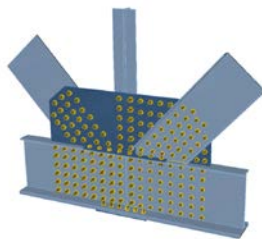

Railway bridge

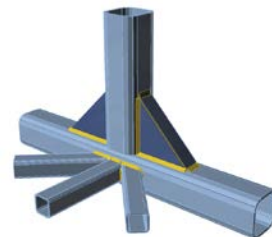

Airport Service Bridge

How CBFEM works

We combine two well-known and trusted methods used by engineers all around the world – Finite Element Method and Component Method:

- Joint is divided into components
- All steel plates are modeled by Finite Element Method assuming ideal elastic-plastic material
- Bolts, welds and concrete blocks are modeled as nonlinear springs
- Finite element model is used for analyzing internal forces in each of the components
- Plates are checked for limit plastic strain – 5 % acc. to EC3, which corresponds well also with recommendations in AISC 360-16 for rotation limit 0.02 rad.
- Each component is checked according to specific formulas defined by the national code, similarly as when using Component Method
- Stiffness of the joint is determined by finite element analysis

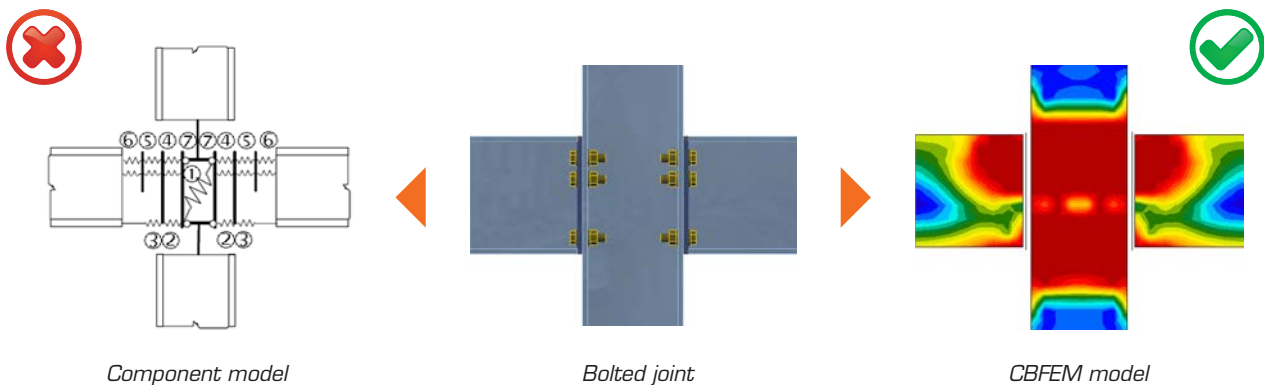

Validation and verification

Results of all tests performed to confirm safety and reliability of CBFEM method and IDEA StatiCa Connection are published and available. Visit our website to review articles, benchmark cases and a preview of book from professor Frantisek Wald devoted to structural steel connections design using CBFEM method:



Benchmark cases for advanced design of structural steel connections

Improving daily work of engineers

IDEA StatiCa Connection can design steel joints and connections of any topology and loaded in all directions. It keeps the whole analysis-design-check process in minutes. This opens a possibility for structural engineers and fabricators around the world to increase productivity of designing steel joints and connections.



BE SAFE

Stay on the safe-side with all checks according to selected national codes at hand at any time.



SAVE TIME

Engineers spend 70% of the connection design time on 30% non-standard cases. Do them in minutes as well.



OPTIMIZE

Know exactly how much material is needed in the joint and take advantage of it.

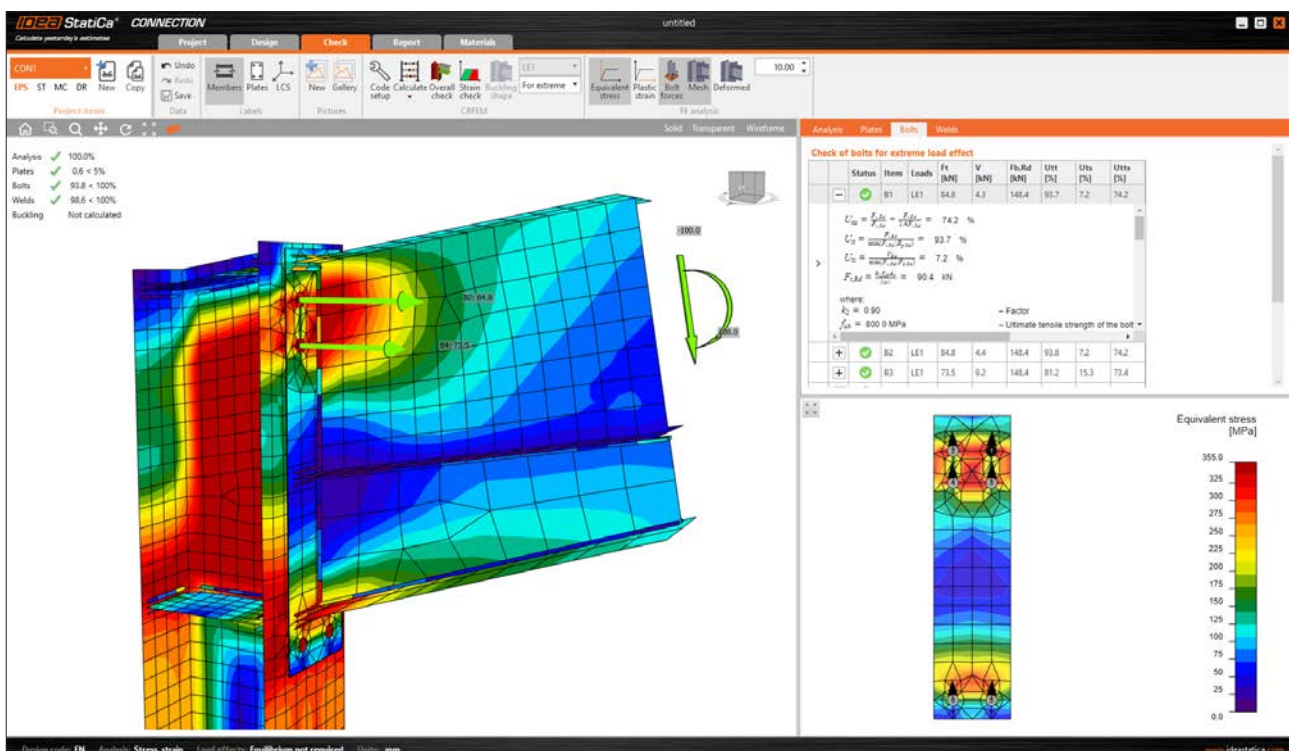

Get your 14-day trial at www.ideastatica.com

Calculate yesterday's estimates

www.ideastatica.com

info@ideastatica.com